

## Universal LED in Ø 5 mm Tinted Diffused Package

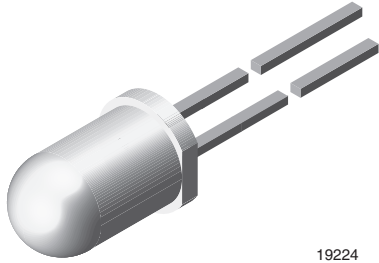

19224

### FEATURES

- For DC and pulse operation
- Luminous intensity categorized
- Standard T-1¾ package
- TLUR640. without stand-offs
- Material categorization:  
For definitions of compliance please see [www.vishay.com/doc?99912](http://www.vishay.com/doc?99912)



### PRODUCT GROUP AND PACKAGE DATA

- Product group: LED
- Package: 5 mm
- Product series: standard
- Angle of half intensity:  $\pm 30^\circ$

### APPLICATIONS

- General indicating and lighting purposes

### PARTS TABLE

PART	COLOR	LUMINOUS INTENSITY (mcd)			at I <sub>F</sub> (mA)	WAVELENGTH (nm)			at I <sub>F</sub> (mA)	FORWARD VOLTAGE (V)			at I <sub>F</sub> (mA)	TECHNOLOGY
		MIN.	TYP.	MAX.		MIN.	TYP.	MAX.		MIN.	TYP.	MAX.		
TLUR6400	Red	4	15	-	10	-	630	-	10	-	2	3	20	GaAsP on GaAs
TLUR6401	Red	4	15	32	10	-	630	-	10	-	2	3	20	GaAsP on GaAs

### ABSOLUTE MAXIMUM RATINGS (T<sub>amb</sub> = 25 °C, unless otherwise specified)

#### TLUR6401

PARAMETER	TEST CONDITION	SYMBOL	VALUE	UNIT
Reverse voltage		V <sub>R</sub>	6	V
DC forward current		I <sub>F</sub>	20	mA
Surge forward current	t <sub>p</sub> ≤ 10 μs	I <sub>FSM</sub>	1	A
Power dissipation	T <sub>amb</sub> ≤ 65 °C	P <sub>V</sub>	60	mW
Junction temperature		T <sub>j</sub>	100	°C
Operating temperature range		T <sub>amb</sub>	- 40 to + 100	°C
Storage temperature range		T <sub>stg</sub>	- 55 to + 100	°C
Soldering temperature	t ≤ 5 s, 2 mm from body	T <sub>sd</sub>	260	°C
Thermal resistance junction/ambient		R <sub>thJA</sub>	500	K/W

### OPTICAL AND ELECTRICAL CHARACTERISTICS (T<sub>amb</sub> = 25 °C, unless otherwise specified)

#### TLUR640., RED

PARAMETER	TEST CONDITION	PART	MIN.	TYP.	MAX.	UNIT	MIN.
Luminous intensity <sup>(1)</sup>	I <sub>F</sub> = 10 mA	TLUR6400	I <sub>V</sub>	4	15	-	mcd
		TLUR6401	I <sub>V</sub>	4	15	32	mcd
Dominant wavelength	I <sub>F</sub> = 10 mA		λ <sub>d</sub>	-	630	-	nm
Peak wavelength	I <sub>F</sub> = 10 mA		λ <sub>p</sub>	-	640	-	nm
Angle of half intensity	I <sub>F</sub> = 10 mA		φ	-	± 30	-	deg
Forward voltage	I <sub>F</sub> = 20 mA		V <sub>F</sub>	-	2	3	V
Reverse voltage	I <sub>R</sub> = 10 μA		V <sub>R</sub>	6	15	-	V
Junction capacitance	V <sub>R</sub> = 0 V, f = 1 MHz		C <sub>j</sub>	-	50	-	pF

#### Note

<sup>(1)</sup> In one packing unit I<sub>Vmin</sub>/I<sub>Vmax</sub> ≤ 0.5

**TYPICAL CHARACTERISTICS** ( $T_{amb} = 25\text{ }^{\circ}\text{C}$ , unless otherwise specified)

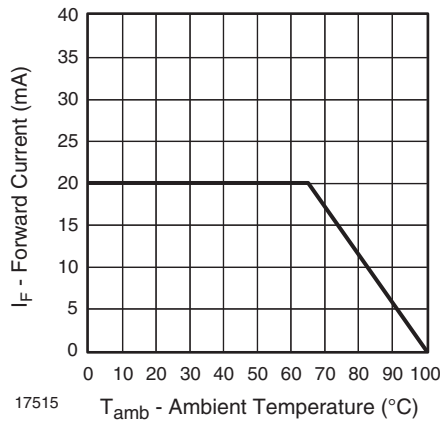

Fig. 1 - Forward Current vs. Ambient Temperature

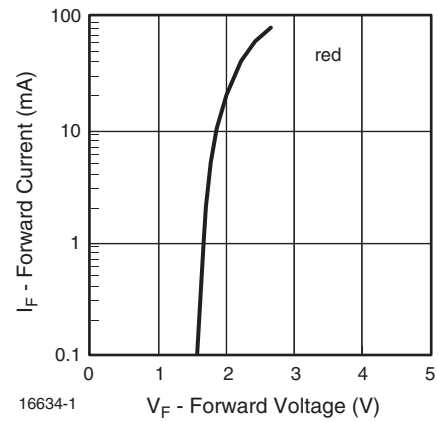

Fig. 4 - Forward Current vs. Forward Voltage

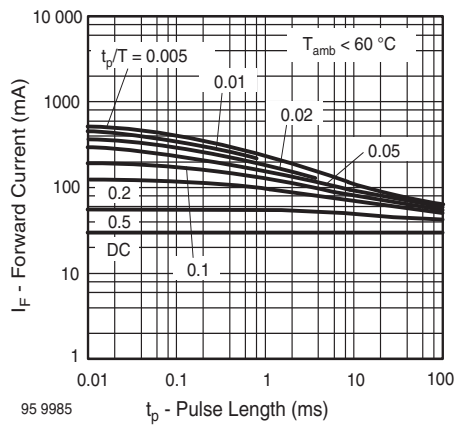

Fig. 2 - Pulse Forward Current vs. Pulse Duration

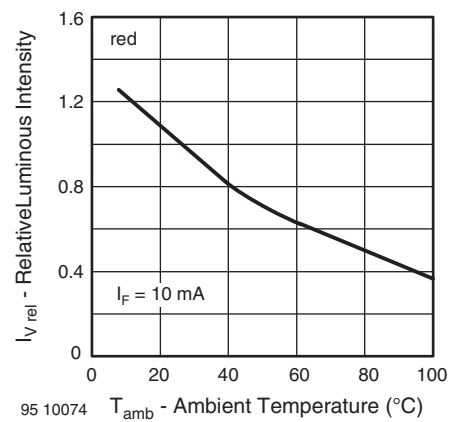

Fig. 5 - Relative Luminous Intensity vs. Ambient Temperature

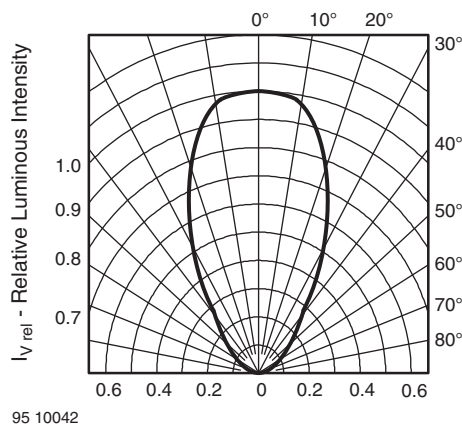

Fig. 3 - Relative Luminous Intensity vs. Angular Displacement

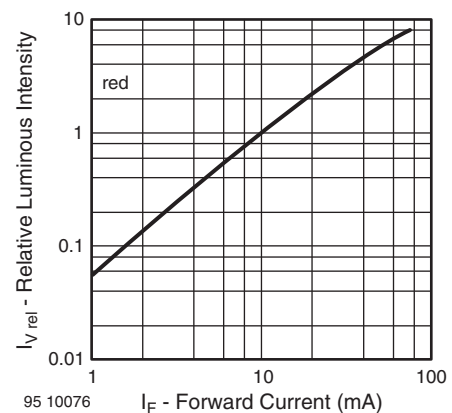

Fig. 6 - Relative Luminous Intensity vs. Forward Current

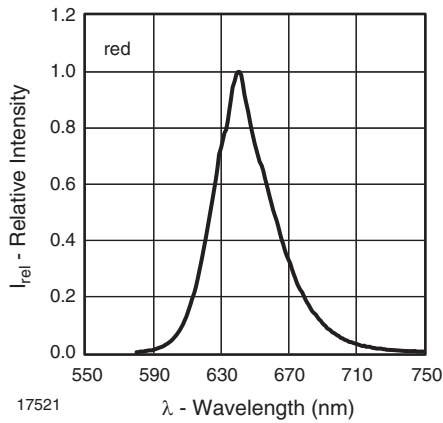
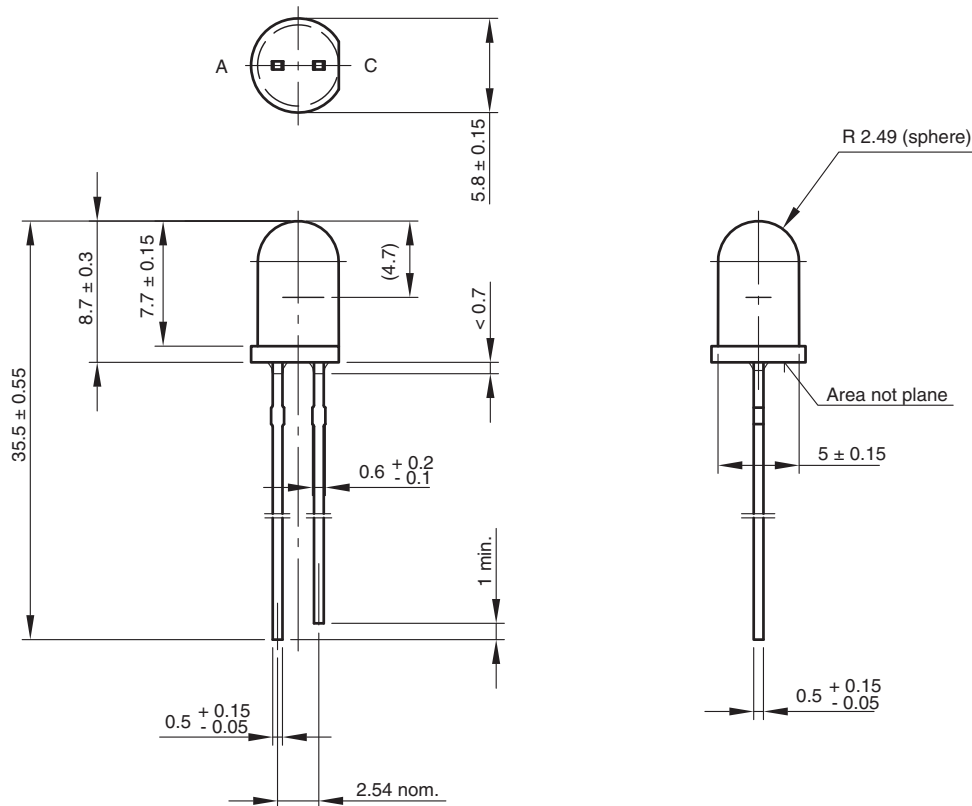

Fig. 7 - Relative Intensity vs. Wavelength

### PACKAGE DIMENSIONS in millimeters



6.544-5259.02-4  
Issue: 8; 19.05.09  
95 10917



## **Disclaimer**

ALL PRODUCT, PRODUCT SPECIFICATIONS AND DATA ARE SUBJECT TO CHANGE WITHOUT NOTICE TO IMPROVE RELIABILITY, FUNCTION OR DESIGN OR OTHERWISE.

Vishay Intertechnology, Inc., its affiliates, agents, and employees, and all persons acting on its or their behalf (collectively, "Vishay"), disclaim any and all liability for any errors, inaccuracies or incompleteness contained in any datasheet or in any other disclosure relating to any product.

Vishay makes no warranty, representation or guarantee regarding the suitability of the products for any particular purpose or the continuing production of any product. To the maximum extent permitted by applicable law, Vishay disclaims (i) any and all liability arising out of the application or use of any product, (ii) any and all liability, including without limitation special, consequential or incidental damages, and (iii) any and all implied warranties, including warranties of fitness for particular purpose, non-infringement and merchantability.

Statements regarding the suitability of products for certain types of applications are based on Vishay's knowledge of typical requirements that are often placed on Vishay products in generic applications. Such statements are not binding statements about the suitability of products for a particular application. It is the customer's responsibility to validate that a particular product with the properties described in the product specification is suitable for use in a particular application. Parameters provided in datasheets and / or specifications may vary in different applications and performance may vary over time. All operating parameters, including typical parameters, must be validated for each customer application by the customer's technical experts. Product specifications do not expand or otherwise modify Vishay's terms and conditions of purchase, including but not limited to the warranty expressed therein.

Except as expressly indicated in writing, Vishay products are not designed for use in medical, life-saving, or life-sustaining applications or for any other application in which the failure of the Vishay product could result in personal injury or death. Customers using or selling Vishay products not expressly indicated for use in such applications do so at their own risk. Please contact authorized Vishay personnel to obtain written terms and conditions regarding products designed for such applications.

No license, express or implied, by estoppel or otherwise, to any intellectual property rights is granted by this document or by any conduct of Vishay. Product names and markings noted herein may be trademarks of their respective owners.